



**OVERVIEW**

The Cascade series provides storage for a wide variety of items. The Mid-Cabinet is a medium width, medium height cabinet in the Cascade grouping, measuring in at 43 5/16" tall, 28 5/8" wide and 19" deep.

**MATERIALS**

The end panels are made of 18-gauge 1" square tubing, welded flush to an 18-gauge end panel. The inside of each end panel is reinforced by 22-gauge hat channels. These hat channels are dual purpose: added strength and for tote rail shelf mounting. The dome top is 18-gauge formed and welded construction, bolted to each end panel and rear panel with a total of 10 machine screw fasteners. The base is a durable 18-gauge steel construction formed and welded to support the entire weight of the unit squarely. Underneath is a heavy welded hat channel reinforcement. The base shelf is attached to both end panels using 4 machine screw fasteners. The rear panel is 18-gauge steel reinforced with up to three vertical hat channels. Two grommet holes (a lower and upper) are punched for convenient wire management and electronic storage. Casters are 4" in diameter, with 2 locking. Optional glides are 3/8" threaded stem.

Riser shelves are sized perfectly for each cabinet size. These riser shelves are made of 3/4" high density particle board with your choice of laminate and bullet T-Mold color. Shelf is suspended 6 inches above the dome top with 4 riser shelf handles, which measure 1 1/2" diameter and come in Platinum powder coat paint finish (0.03" thickness). These riser shelf handles bolt on from underneath the dome top with a hefty 3" washer.

The optional doors include a secure and reliable locking mechanism, which engages lock rods into the dome top and the base shelf. Doors also come with urethane ergonomic and modern door handles of your color choice. The fully hinged doors articulate 270 degrees, free of obstruction.

**DIMENSIONS**

Model	Description	D"	W"	H"	WT
<b>Shelves</b>					
51100000P	Open w/shelves	19	29	43.3	81
52100000P	Doors w/shelves	19	29	43.3	97
511V00000P	Open w/shelves & riser	19	29	50	101
521V00000P	Doors w/ shelves & riser	19	29	50	117

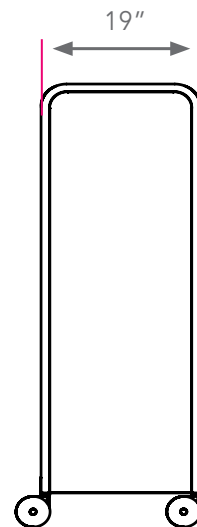
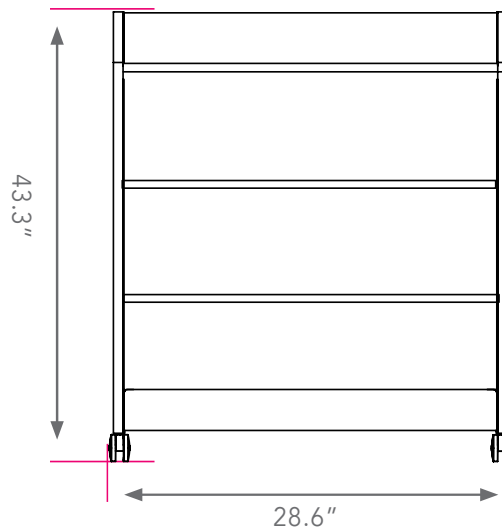

**STANDARD LAMINATE OPTIONS**





Want to specify a different laminate?

No problem. If you have 20 or more tops of the same color -60 or -38 there is no upcharge. Have 20 or less? We can quote for you with the Wilsonart code and - finish style. We can specify other laminates - call to inquire and get a quote.

**SUGGESTED LAMINATE OPTIONS** *Cascade Riser Shelves*

						
ASIAN NIGHT 7949-60	BOARDWALK OAK 7983-60	BUKA BARK 7982-60	CLASSIC LINEN 4943-60	FLAX LINEN 4990-60	FRENCH PEAR 8220-60	FUSION MAPLE 7909-60
						
GREY NEBULA 4622-60	HIGH RISE 4996-60	MISSION MAPLE 7990-60	NEW AGE OAK 7938-60	NORTH SEA GRAY D90-60	PALISADES OAK 7987-60	PEWTER MESH 4878-60
	<p>All 15 of the standard laminates are -60 finish, if you need to match a laminate from a previous year, please let us know on your order (example Pewter Mesh 4878-38, our standard is -60).</p>					<p>When the WilsonArt Laminate code includes a "Y", "K", "-12" "-78", "Aeon" etc, these are special laminates with an upcharge, even when it contains -38 or -60.</p>
WILD CHERRY 7054-60						

**STANDARD END PANEL AND RISER EDGE COLOR OPTIONS**

			
APPLE	BLACK	CERULEAN	CHARCOAL
			
NAVY	PERSIAN BLUE	PLATINUM	

**FRAME COLOR**

PLATINUM

**END PANEL AND RISER EDGE COLOR OPTIONS WITH ADDITIONAL LEAD TIME**

			
BLUEBERRY	BURGUNDY	FOREST GREEN	ORANGE
			
PURPLE	RED	YELLOW	